

ACHTECK

WYSOKOWYDAJNE
FREZY WALCOWO-CZOŁOWE
NA PŁYTKI APMT

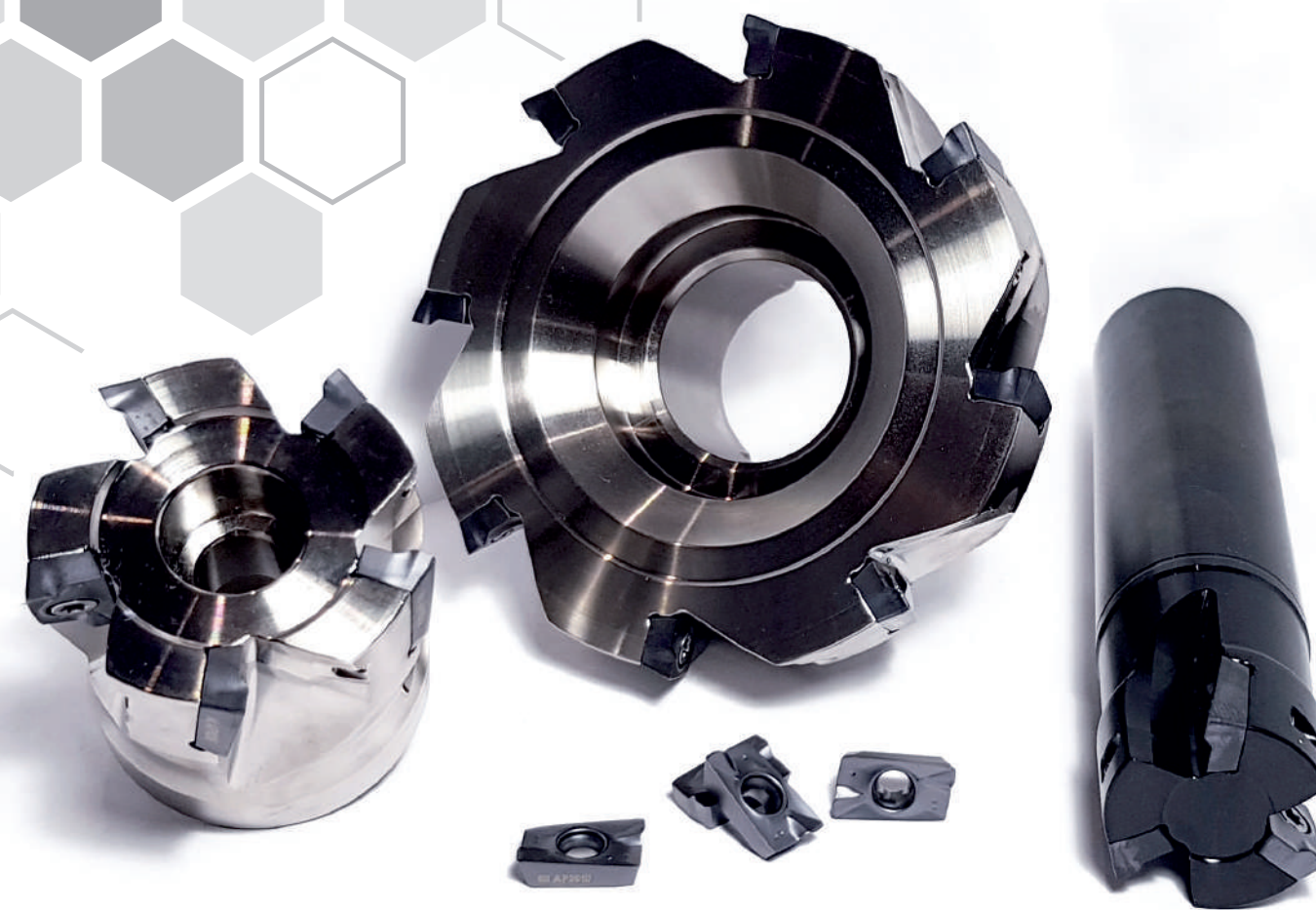

GANZHOU ACHTECK TOOL TECHNOLOGY CO., LTD.

Wyłączny dystrybutor narzędzi skrawających firmy Achteck w Polsce

F.P.U.H. LIMES Maciej Mojecki

ul. Hauke Bosaka 11

25-217 Kielce

tel.: + 48 502-209-672



e-mail: biuro@achteckpoland.pl

www.achteckpoland.pl

www.achteckpoland.pl

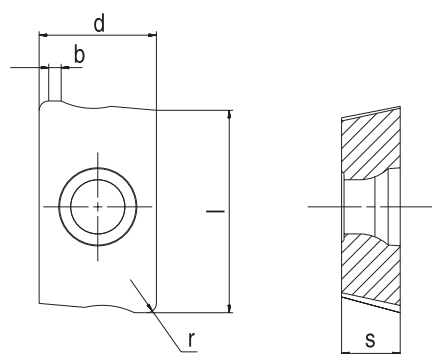
PŁYTKI APMT 11/16



Insert	Designation	Dimensions					Grades						
		l	d	s	r	b	CVD coated		PVD coated		Uncoated		
							AC301P	AC301K	AP301U	AP351U		AP401U	AP351K
	APMT 1135PDER	11.31	-	3.5	0.8	1.25			•	•			
	APMT 1604PDER	17.32	-	5.17	0.8	1.54			•	•			

FREZY NA PŁYTKI APMT 1604

CHWYT CYLINDRYCZNY

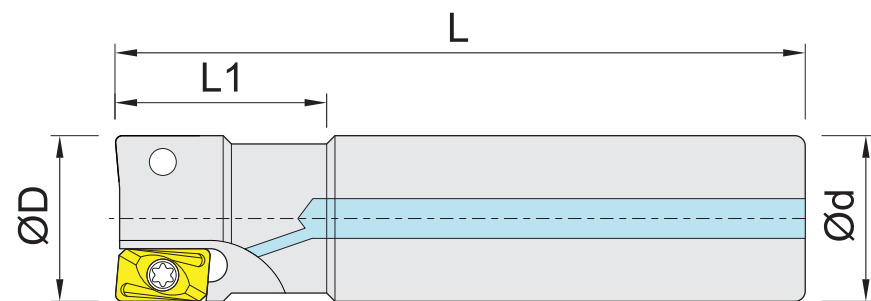
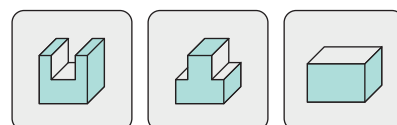

Kod produktu	Chłodzenie wewnętrzne	Wymiary, mm				Ilość ostrzy	Płytki	Części zamienne	Waga Kg
		D	d	L	L1				
BAP4-252-S25-150	BRAK	25	25	150	40	2	APMT 1604	2	0.58
BAP4-262-S25-150		26	25	150	30	2			0.58
BAP4-262-S25-200		26	25	200	30	2			0.77
BAP4-323-S32-150		32	32	150	45	3			0.95
BAP4-333-S32-150		33	32	150	35	3	3	0.95	
BAP4-333-S32-200		33	32	200	35	3		1.26	

MOCOWANIE TRZPIENIOWE

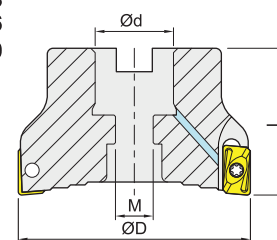

Ø 50
Ø 63
Ø 66
Ø 80

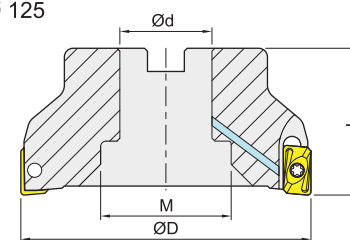

Ø 100
Ø 125



Kod produktu	Chłodzenie wewnętrzne	Wymiary, mm				Ilość ostrzy	Płytki	Części zamienne	Waga Kg
		D	d	L	M				
BAP4-404-16.0	BRAK	40	16.0	40	9	4	APMT1604	3	0.23
BAP4-504-22.0		50	22.0	50	11	4			0.54
BAP4-505-22.0		50	22.0	50	11	5			0.51
BAP4-635-22.0		63	22.0	50	11	5			0.77
BAP4-636-22.0		63	22.0	50	11	6			0.75
BAP4-806-27.0		80	27.0	50	13	6			1.18
BAP4-808-27.0		80	27.0	50	13	8			1.14
BAP4-1008-32.0		100	32.0	50	45	8			1.65
BAP4-1259-40.0		125	40.0	63	60	9			2.33

Insert	Spare parts	Screw 	Wrench 
APMT1604....	②	MS4009A	ETF15
APMT1604....	③	MS4011A	ETF15